

F

E

D

C

B

A

4

3

2

1

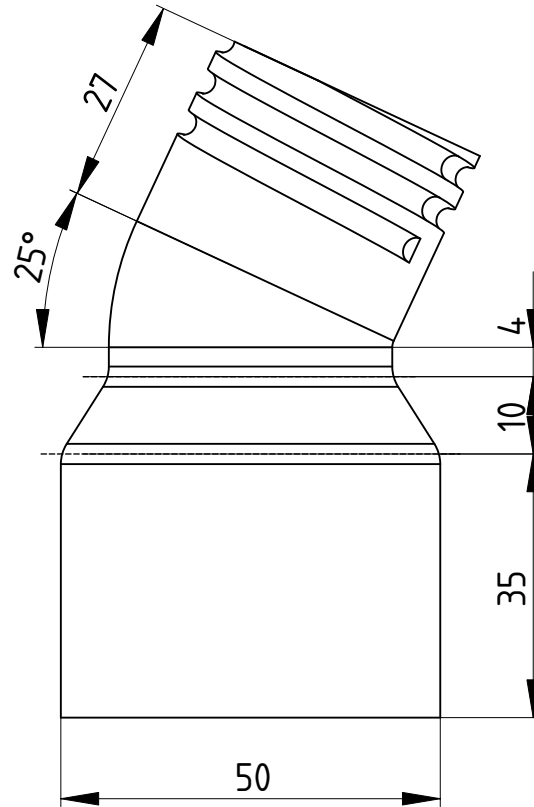
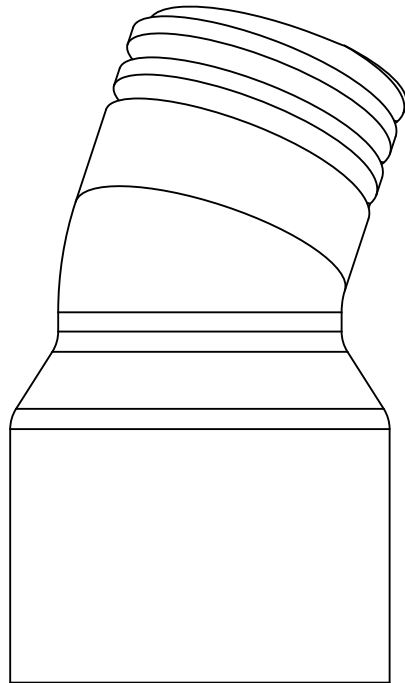

4

3

2

1

DESIGNED BY: Tobias Rohleder		Adapter JOF001		G	—
DATE: 26.08.2021		Durchmesser 50mm		F	—
SIZE A4				E	—
				D	—
SCALE 1:1	WEIGHT (kg) 0,05	DRAWING NUMBER 1.02	SHEET 1	C	—
This drawing is our property; it can't be reproduced or communicated without our written consent.				B	—
				A	—



alle Maße in Millimeter

F

E

D